

# REINER

## *jetStamp 990*



Operating Manual

GB

# Table of contents

<b>I Your jetStamp</b>	<b>5</b>
1.1 Operating elements.....	6
1.2 Display and button function.....	8
1.3 Main menu.....	11
1.3.1 Cartridge change .....	11
1.3.2 Device lock .....	11
1.3.3 Bluetooth Activate (activate Bluetooth) .....	12
1.3.4 Date/time .....	12
1.3.5 Numbering machine .....	12
1.3.5.1 Reset (zero).....	13
1.3.5.2 Value.....	13
1.3.5.3 Minimum.....	13
1.3.5.4 Maximum.....	14
1.3.5.5 Step width.....	14
1.3.5.6 Repetition.....	14
1.3.6 Maintenance .....	15
1.3.7 Settings .....	15
1.3.8 Device info .....	17
1.3.9 Hotkey (shortcut key) .....	17
<b>II Important notes</b>	<b>19</b>
2.1 Rechargeable batteries.....	19
<b>III Your safety</b>	<b>20</b>
3.1 Safety, description.....	20
3.2 Safety notes on rechargeable batteries.....	21
3.3 Safety notes.....	22
3.4 Safe handling of print cartridges.....	22
<b>IV Preparation and commissioning</b>	<b>23</b>
4.1 Commissioning.....	23
4.1.1 Rechargeable batteries .....	24
4.1.1.1 Inserting rechargeable batteries .....	24
4.1.1.2 Charging rechargeable batteries.....	24
4.1.2 ON/OFF function .....	25
4.1.3 Inserting the print cartridge .....	25
4.2 Setting date and clock time.....	27
4.3 Set Summertime.....	27
4.4 Printing the print image.....	28
4.5 Saved print images.....	29
4.5.1 Overview of factory-stored print images .....	29
4.6 Selecting print image.....	31
4.7 Edit print image with hotkey function.....	31

4.7.1	Edit text .....	31
4.7.2	Edit numbering machine .....	31
4.8	Activate Bluetooth.....	32
4.9	Installing the REINER PCset software.....	32
4.9.1	System requirements .....	33
4.9.2	Installing the software .....	33
4.10	Firmware update.....	33
 <b>V Software application 990 REINER PCset</b>		<b>35</b>
5.1	Preparing jetStamp 990 for REINER PCset.....	35
5.2	Starting the REINER PCset software.....	35
5.3	Operating interface.....	36
5.3.1	Menu bar .....	36
5.3.1.1	File .....	37
5.3.1.2	Edit .....	37
5.3.1.3	View .....	37
5.3.1.4	Presettings.....	37
5.3.1.5	Help .....	38
5.3.2	Toolbar .....	38
5.3.3	Objects .....	39
5.4	Establishing Bluetooth connection.....	40
5.5	Example workflow: Generating the print image.....	40
5.5.1	Configuring the print image .....	41
5.5.2	Transferring the print images .....	41
5.6	Objects settings.....	42
5.6.1	Text .....	42
5.6.1.1	Presettings.....	42
5.6.1.2	Context menu text object.....	43
5.6.2	Date/Time .....	44
5.6.2.1	Presettings.....	44
5.6.2.1.1	Tab File - Settings Date / Clock time.....	45
5.6.2.2	Context menu date/time object.....	46
5.6.3	Numbering machine .....	47
5.6.3.1	Presettings.....	48
5.6.3.1.1	Tab File - Settings Date/time/numbering machine.....	49
5.6.3.2	Context menu numbering machine object.....	50
 <b>VI Maintenance</b>		<b>51</b>
6.1	Changing the print cartridge.....	51
6.2	Cleaning the contacts of the print cartridge.....	53
6.3	Clean nozzles.....	54
6.3.1	Manual nozzle cleaning .....	54
6.4	Clean print carriage.....	54
6.5	Clean housing.....	55
 <b>VII Recognising and removing interferences</b>		<b>56</b>
7.1	Warning messages.....	56
7.2	Correctable error messages.....	56
7.3	Device error messages.....	57

<b>VIII Technical data and accessories</b>	<b>58</b>
8.1 Type plate.....	58
8.2 Technical data.....	59
8.3 Transport and disposal.....	60
8.4 Accessories.....	60
<b>IX Contact</b>	<b>61</b>
<b>Index</b>	<b>62</b>

# 1 Your jetStamp

**REINER***jetStamp 990*

## 1.1 Operating elements

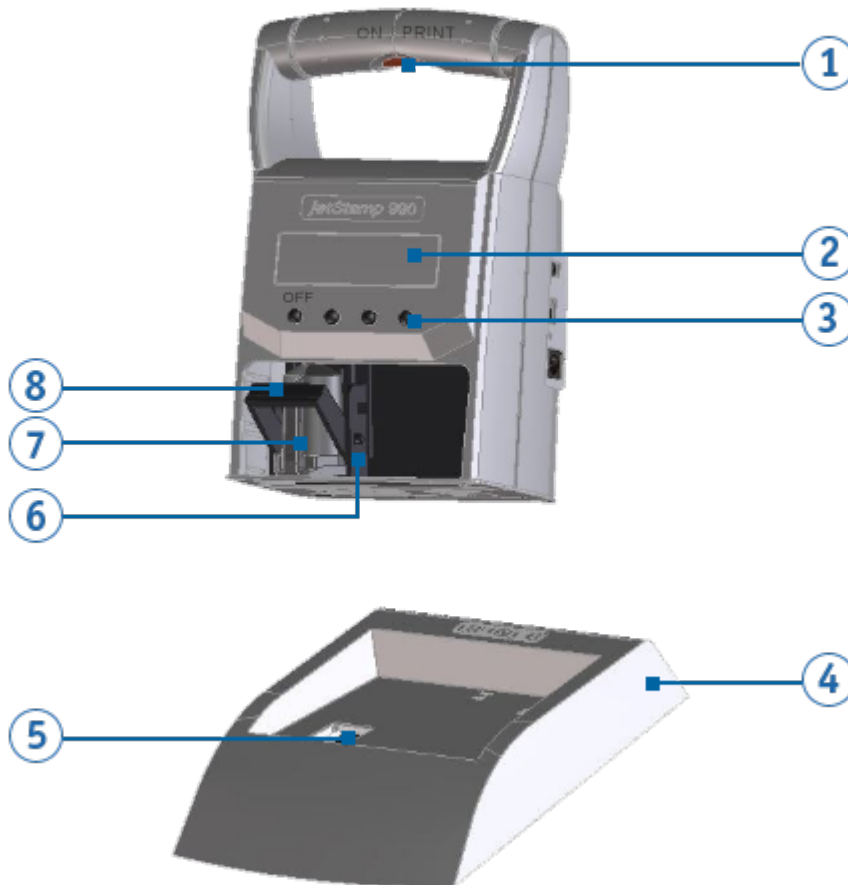
**A**

**B**

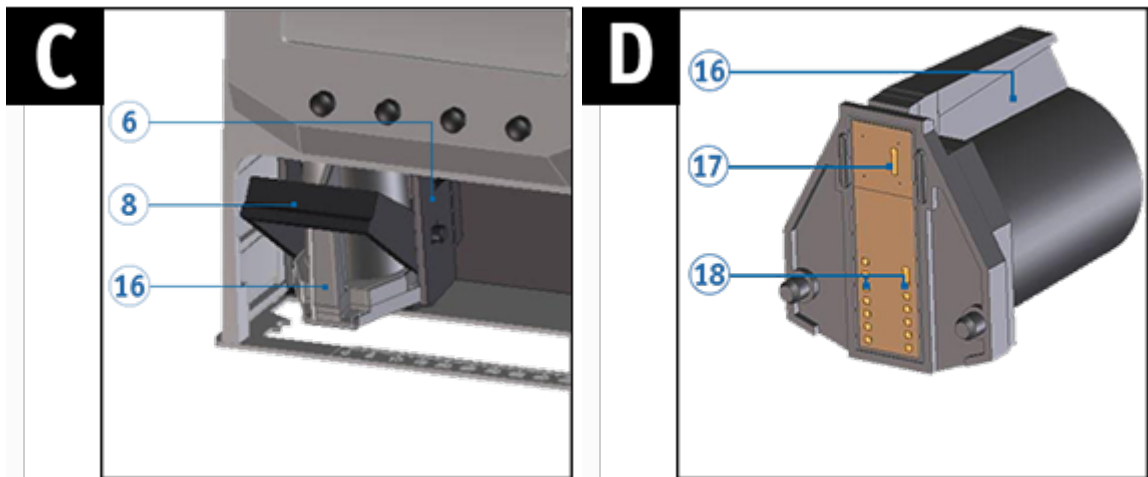

- |   |                                       |
|---|---------------------------------------|
| ① Trigger button + <a href="#">switch on the device</a>               | ⑩ Flap for battery compartment        |
| ② Display   | ⑪ Reset button                        |
| ③ Key pad with 4 push-buttons + <a href="#">switch off the device</a> | ⑫ Connection socket for mains adapter |
| ④ Basis station   | ⑬ Charging indicator                  |
| ⑤ Ink cleaning station  | ⑭ Micro USB socket                    |
| ⑥ Print carriage  | ⑮ Jack socket for external triggering |
| ⑦ Print cartridge   | ⑯ Grip strip print cartridge          |
| ⑧ Locking bracket   | ⑰ Nozzles print cartridge             |
| ⑨ Battery compartment   | ⑱ Print cartridge contacts            |



## 1.2 Display and button function

The display depends on the respective menu context. The starting screen of the main menu is displayed.

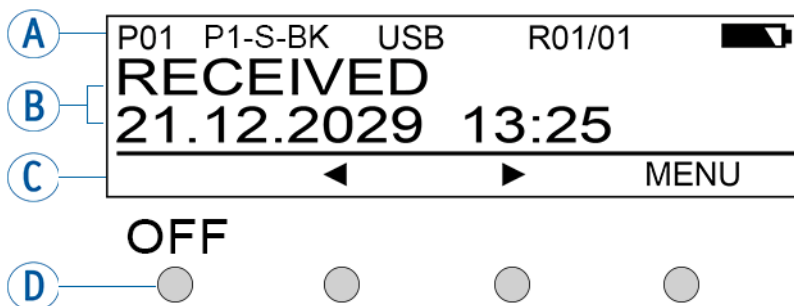
The display is structured according to the following sections:



**A Header**

P01	Number of the set print image
P1-S-BK	Cartridge type used
USB	USB active
BT/BTC	Bluetooth active/Bluetooth connected
01/01	Repeat switching of the numbering machine 1
180	Imprint rotated by 180 degrees
	Battery level
	Battery is charging

**B Set print image**

Text, date/time or numbering machine

**C Menu bar with menu items and commands**

	Next page. Forward/back through print images or menu.
[MENU] [SELECT]	Menu. Access to the main menu and menu selection – confirms entries and completes function settings.
[RETURN]	Previous page. Returns to the previous display (submenu / main menu or exit from main menu / hotkey menu).
[OK]	Selection. Confirms entries and completes function settings.
[NO/TXT]	Hotkey (shortcut key) / edit on the device. Hotkey settings are activated. See " <a href="#">Hotkey</a> " and under Edit print image - " <a href="#">Edit text</a> ".
[SET]	Set. Confirm menu selection for editing.
[RESET]	Reset. Reset the value of the numbering machine in the menu selection.
[Next V]	Hotkey (shortcut key) / Set next value.

**D Four push-buttons**

The **four push-buttons** are each assigned to the menu item or command in the display menu bar above; **the leftmost button** is also used [to switch off the device](#) (press and hold for approx. 1 second).

## 1.3 Main menu

### Call up the menu navigation:



- ▶ Press the [MENU] button.
- ▶ Use the arrow buttons ◀ ▶ to scroll through the menus.
- ▶ \* The **main menus** are displayed on the top layer.
- ▶ \* Within a main menu, additional **submenus** are available for selection.
- ▶ Confirm with [SELECT] or [OK].
- ▶ Use [RETURN] to return to the previous menu .

 The menu navigation of the device is divided into **main menus** and **submenus**. There are **9 main menus** for selection:

[Cartridge change](#)  
[Device lock](#)  
[Bluetooth Activate \(activate Bluetooth\)](#)  
[Date/time](#)  
[Numbering machine](#)  
[Maintenance](#)  
[Settings](#)  
[Device info](#)  
[Hotkey \(shortcut key\)](#)



 For the button functions, see "[Display and Button Functions](#)"



### 1.3.1 Cartridge change

- ▶ Selecting [SELECT] moves the print carriage  to the middle of the device so that the print cartridge can be inserted/changed.
- ▶ Selecting [SELECT] again moves the print carriage  back to its basic position.
- ▶ Selecting [RETURN] leaves the menu.

 Also see "[Menu selection](#)", "[Inserting the Print Cartridge](#)" and "[Changing the Print Cartridge](#)"

### 1.3.2 Device lock

 Print images can be protected with a password.  
 When the print images are protected, the menu will show "Device Unlock". This means that a password must be entered.

- ▶ Selecting [SELECT] enables or disables the device lock.
- ▶ The symbol in the status indicator  in the REINER PCset switches from  to .
- ▶ Selecting [RETURN] leaves the menu.

 Also see "[Menu selection](#)" and "[Settings – Change password](#)".

### 1.3.3 Bluetooth Activate (activate Bluetooth)

 Only model 990-001 is Bluetooth capable.

 Bluetooth cannot be activated while an USB connection is active.

 If Bluetooth is active, the battery runtime reduces since Bluetooth is active in standby mode as well.

▶ Selecting [SELECT] enables or disables Bluetooth.

▶ Selecting [RETURN] leaves the menu.

### 1.3.4 Date/time

#### **Change Date/Time (date/time change)**

Function: Setting the date and time

▶ Push the button [SELECT] again and use the buttons ◀ ▶ and [OK] to set the date/time.

▶ Select the button [OK] to accept the changes.

▶ Selecting [RETURN] leaves the menu.

 Also see "Preparation and commissioning" under "[Setting Date and Time](#)".

#### **Summertime**

Function: Setting whether and when the clock automatically switches between summer time and regular time.

▶ Selection between Europe/America/None

\* Europe: last week of March – October

\* America: March – November

\* None: no automatic switching

 See "Preparation and commissioning" under "[Setting summertime](#)" and "[Menu navigation](#)".

### 1.3.5 Numbering machine

#### **Numb. machine 1 - 4 (numbering machine 1 - 4)**

The numbering machine serves sequential numbering.

Up to 4 different numbering machines can be set, which can be individually adapted in a print image.

A numbering machine used in the selected print image is marked with an appended "\*" here. The specified "Numb. machine 1", for example, is displayed as "Numb. machine 1\*".

[Reset](#)

[Value](#)

[Minimum](#)

[Maximum](#)

[Step width](#)  
[Repetition](#)

 Also see "[Menu selection](#)" and "Preparing and commissioning - Edit print image/ [edit numbering machine](#)".

 See "Software application 990 PCset", "[Settings Objects - Numbering Machine](#)".

#### 1.3.5.1 Reset (zero)

Function:

The reset function resets the selected numbering machine to the original value. The original value is the minimum value for numbering machines that are counting up and the maximum value for numbering machines that are counting down.

- ▶ Press [SELECT].
- ▶ The display shows "Really?". This is a safety query to confirm whether this numbering machine should really be reset.
- ▶ Press [OK].  
the display shows "Reset done!". The reset has now been carried out.
- Or -
- ▶ Push [RETURN].  
to cancel the operation.
  
- ▶ To exit from the menu, press [RETURN] four times.  
The selected print image appears.

 Also see "[Menu selection](#)".

#### 1.3.5.2 Value

Function:

The value function changes the value of the selected numbering machine:

- ▶ Press [SELECT].  
The display shows the current value of the numbering machine.
- ▶ With ◀ ▶, the value can be increased/decreased.
- ▶ When the desired value is selected, press [OK]. The next digit of the numbering machine can now be changed.
- ▶ When the desired value is set, press the [OK] button to confirm the set value for the selected numbering machine.
- ▶ To exit from the menu, press [RETURN] four times.  
The selected print image appears.

#### 1.3.5.3 Minimum

Function:

The minimum function changes the minimum value of the selected numbering machine:

- ▶ Press [SELECT].  
The display shows the current value of the numbering machine.
- ▶ With ◀ ▶, the value can be increased/decreased.
- ▶ When the desired value is selected, press [OK]. The next digit of the numbering machine can now be changed.
- ▶ When the desired value is set, press the [OK] button to confirm the set value for the selected numbering machine.
- ▶ To exit from the menu, press [RETURN] four times.  
The selected print image appears.

#### 1.3.5.4 Maximum

Function:

The maximum function changes the maximum value of the selected numbering machine:

- ▶ Scroll to desired numb. machine 1 – 4 with ◀ ▶, press [SELECT] to select.
- ▶ Scroll with ◀ ▶, until "Numb. machine \* Maximum" is displayed.
- ▶ Press [SELECT].  
The display shows the current value of the numbering machine.
- ▶ With ◀ ▶, the value can be increased/decreased.
- ▶ When the desired value is selected, press [OK]. The next digit of the numbering machine can now be changed.
- ▶ When the desired value is set, press the [OK] button to confirm the set value for the selected numbering machine.
- ▶ To exit from the menu, press [RETURN] four times.  
The selected print image appears.

#### 1.3.5.5 Step width

Function:

The step width function changes the step width of the numbering machine:

- ▶ Scroll to desired numb. machine 1 – 4 with ◀ ▶, press [SELECT] to select.
- ▶ Scroll with ◀ ▶, until "Numb. machine \* Step width" is displayed
- ▶ Press [SELECT].  
The display shows the current step width of the numbering machine.
- ▶ With ◀ ▶, the value can be increased/decreased.
- ▶ When the desired value is set, press the [OK] button to confirm the set step width for the selected numbering machine.
- ▶ To exit from the menu, press [RETURN] four times.  
The selected print image appears.

#### 1.3.5.6 Repetition

Function:

The repetition function changes the repetition value of the selected numbering machine:

- ▶ Scroll to desired numb. machine 1 – 4 with ◀ ▶, press [SELECT] to select.
  - ▶ Scroll with ◀ ▶, until "Numb. machine \* Repetition" is displayed.
  - ▶ Press [SELECT].
  - ▶ The display shows the current repeat value of the numbering machine.
  - ▶ With ◀ ▶, the value can be increased/decreased.
  - ▶ When the desired value is set, press the [OK] button to confirm the set repetition value for the selected numbering machine.
  - ▶ To exit from the menu, press [RETURN] four times.
- The selected print image appears.

 Also see "[Menu selection](#)".

### 1.3.6 Maintenance

#### Clean head START

is used to clean the print cartridge. An image is printed that activates all nozzles of the print cartridge. This removes any blockages or deposits in the nozzles.

It may be necessary to repeat this cleaning process several times to achieve optimum printing results.

 Another option for nozzle cleaning is "[Manual nozzle cleaning](#)". All other maintenance instructions can be found under "[Maintenance](#)".

### 1.3.7 Settings

 Also see: [Menu selection](#) - navigation to the submenus.

#### Cartridge type

Function: Selection of the print cartridge type used.

- ▶ Selection options:
  - P1-S-BK (51604A)
  - P1-S-RD (51605R) \* No longer adjustable from date of manufacture QC 12/2025
  - P1-EF-AUB
  - P1-EF-RD
  - P1-MP2-BK \* No longer adjustable from date of manufacture QC 12/2025
  - P1-MP3-BK
  - P1-MP4-BK
  - P1-MP6-YE
  - P1-MP EM790BKQDX

 Also see "Technical data and accessories" under "[Accessories](#)".

#### Cleaning mode

Function: Selection of the desired cleaning mode.

- **"In Base" (operating mode with basis station):**  
Spitting only within the basis station.
- **"Interval" (operating mode without basis station):**  
Spitting both inside and outside the basis station.
- **"Off" (no spitting):**  
Spitting is deactivated.

**Note:**

The following functions are only permitted when using the **Precision clip CAP 990**. Without the clip, ink may leak uncontrollably and contaminate the device or the surrounding area.

- **"Low" (operating mode "before printing start"):**  
Spitting before the imprint is started  
(LOW mode, recommended for print cartridge P1-S-BK (51604A))
- **"Medium" (operating mode „before printing start“):**  
Spitting before the imprint is started  
(MEDIUM mode, recommended for the print cartridges: P1-MP3-BK, P1-EF-AUB and P1-EF-RD)
- **"High" (operating mode "before printing start"):**  
Spitting before the imprint is started  
(HIGH mode, recommended for print cartridges: P1-MP4-BK, P1-MP6-YE and P1-MP EM790BKQDX)



With the "Off" setting, the print cartridge nozzles are not flushed, regardless of whether it is inside or outside the basis station. This makes sense if the 990 device is continuously operated. Unnecessary deactivation should be avoided to prevent the ink from drying out.

### Double print

Function: Activate or deactivate the double print.

- ▶ Selecting [SELECT] the double print is switched "ON" or "OFF".

### Print alignment 0 / 180 deg

Function: Set whether the imprint should be made normally or rotated by 180°

- ▶ With [SELECT] you can choose between "0 deg rotated" (normal imprint) and "180 deg rotated" (imprint rotated by 180 degrees).

### Password menu

Function: Switch menu access on or off with password.

- ▶ Selecting [SELECT] to choose between "ON" and "OFF".  
"ON" means that the menu access is password-protected. You can only return to the menu after entering the password.  
The print images can, however, be selected and printed out on the device.



Ex works and after selecting Settings/Factory settings, the password is set to "0000".

### Password change

Function: Set new password for menu access.

- ▶ After selecting [SELECT], you will be asked to assign a new password.
- ▶ Confirm your selection with [OK] or undo it with [RETURN].

### Ext. trigg. delay

Function: Delays the start of the print process if printing is triggered by an external signal.

- ▶ Display: "Ext. trigg. Delay 0 / 2500 [ms]".
- ▶ Only for external triggering:  
By selecting [SELECT], the imprint start is delayed for (delay) 0....2500 ms.

### Factory Reset (factory settings)

Function: Resets the jetStamp 990 to the delivery state.

- ▶ Select [SELECT] to reset the *jetStamp* 990 to the delivery condition.

 All settings and saved print images will be lost. The print images at delivery are not restored.

## 1.3.8 Device info

### Model

- ▶ Select [SELECT] to display the model and serial number.

### Software version

- ▶ Select [SELECT] to display the firmware status.

### ESP32 version

- ▶ Select [SELECT] to display the firmware status of the Bluetooth building block.

### Counter lifetime

- ▶ Select [SELECT] to display the counter (lifetime counter = number of imprints since device commissioning).

 Also see "Software application 990 REINER PCset" under "Operating interface" "[Menu bar help](#)".

## 1.3.9 Hotkey (shortcut key)

### Choose between 6 hotkey functions

The hotkey is a function with which you can edit the selected print image.

The selected function can be called up with the [NO/TXT] button.

The following 5 functions are available:

- ▶ Function "**Num / Text edit**" to edit the selected text or numbering machine.
- ▶ By selecting "**None**", the [NO/TXT] button disappears from the display and editing is not possible.

- ▶ Function "**Num reset**" to reset the selected numbering machine to the original value.
- ▶ Function "**Num last repet.**" to switch the repetition value of the selected numbering machine back by 1.
- ▶ Function "**Num next repet.**" to switch the repetition value of the selected numbering machine forward by 1.
- ▶ Function "**Num next value**" to switch the value of the selected numbering machine forward by 1.

 Upon delivery of the device, the hotkey function "Num/Text edit" is preset.

 See "Preparation and commissioning" under "[Editing print image with the hotkey function](#)"

## 2 Important notes

Before commissioning of the *jetStamp* 990 always read the operating instructions and in particular the safety notes with care. This prevents insecurities in handling of the marking devices and connected safety risks to keep you safe and avoid damage to the device.

[Rechargeable batteries](#)

### 2.1 Rechargeable batteries

The charging of the batteries is electronically controlled. This ensures that the battery cells are charged optimally and gently.



#### Recharging

► Fully charge rechargeable batteries before first application. Duration approx. 3 hours.

After the first full charge, the batteries do not yet reach full capacity. You must expect that the normal service times will be undercut.

#### Reaching full capacity

Full capacity is achieved when the batteries are completely discharged and charged several times.

 Charging is possible via the enclosed plug-on mains adapter or the connection socket , as well as via a micro USB socket .

## 3 Your safety

[Safety description](#)

[Safety notes on rechargeable batteries](#)

[Safety notes](#)

[Safe handling of print cartridges](#)

### 3.1 Safety, description

#### **DANGER**

Warnings of dangers that lead to **death or severe injury directly** if not observed.

#### **WARNING**

Warnings of dangers that may lead to **death or severe injury** if not observed.

#### **CAUTION**

Warnings of dangers that may lead to **injury** if not observed.

#### **NOTICE**

Warnings of dangers that may lead to **property damage** if not observed.



Observe the operating instructions.

▶ You are asked to perform actions here.



Notes and advice to make handling your *jetStamp 990* even easier.



Notes on instruction videos.

## 3.2 Safety notes on rechargeable batteries

Rechargeable batteries are subject to wear. A longer service life than six months cannot be warranted.

### WARNING

Possible explosion in contact with fire.

- ▶ Do not forcefully open rechargeable batteries.
- ▶ Do not expose rechargeable batteries to severe heat
- ▶ Do not expose rechargeable batteries to extremely low barometric pressures.

### CAUTION

Injuries resulting from destruction of the battery when using unsuitable rechargeable batteries or non-rechargeable batteries.

- ▶ Only use the batteries intended for the device.

### Type usage

Use only the enclosed mains adapter to charge the rechargeable batteries.

Only use rechargeable batteries (two each) type nickel metal hydride (NiMH, REINER item number: 946 192 - 000) of build AA.

Always replace all flat rechargeable batteries at once.  
Unauthorised batteries may cause damage or malfunction.

- ▶ Use only prescribed rechargeable batteries.

### Insertion

Observe polarity of rechargeable batteries when inserting (refer to the battery symbols in the battery compartment)!

### 3.3 Safety notes

**⚠ CAUTION**

Possible tripping and damage to the device due to device lines lying freely in the room.

- ▶ Place the device lines so that they do not pose any danger source!

**NOTICE**

Damage to the device at improper transport.

- ▶ Only use packaging that provides protection from impact and shock for the device!

**NOTICE**

Damage to the device by dewing.

- ▶ Before commissioning, wait until the device has reached room temperature and is completely dry!

 Only trained specialists should perform repairs.

### 3.4 Safe handling of print cartridges

**⚠ WARNING**

Possible blindness due to eye contact with ink.

- ▶ Do not point the *jetStamp* 990 nozzles against people's faces!

**⚠ CAUTION**

Damage to health caused by ingestion of ink.

- ▶ Do not swallow!
- ▶ Keep the print cartridge out of the reach of children!

## 4 Preparation and commissioning

 Only connect the device to the PC after the REINER PCset software has been installed (see "[Installing the REINER PCset software](#)").  
With the installation of the PCset software, the required USB drivers are installed. If a connection is established between the PC and the device, the USB drivers are automatically detected and loaded. If the device is connected without installing the PCset software, the installation of the device drivers fails.

[Commissioning of the \*jetStamp 990\*](#)

[Setting date and clock time](#)

[Setting summertime](#)

[Printing the print image](#)

[Saved print images](#)

[Selecting print image](#)

[Editing print image with the hotkey function](#)

[Activating Bluetooth](#)

[Installing the REINER PCset software](#)

[Firmware update](#)

### 4.1 Commissioning



Find a clip on our homepage [www.reiner.de](http://www.reiner.de) or on YouTube.



The menu selection on the device is in English only (see "[Main menu](#)").

[Rechargeable batteries](#)

[ON/OFF function](#)

[Inserting the print cartridge](#)

## 4.1.1 Rechargeable batteries

The supplied batteries must be fully charged before first application. Please allow **more than 2 hours** for this!

[Inserting rechargeable batteries](#)

[Charging rechargeable batteries](#)

### 4.1.1.1 Inserting rechargeable batteries

**i** [Please note before first use:](#)

- Fully charge the batteries before first use (charging time: approx. 2 hours).
- The batteries are fully charged when the **green charging indicator 13** is off.
- **Always replace all flat rechargeable batteries at once.**
- The **date, time and counter reading** are received when the battery is replaced.

Inserting rechargeable batteries ⇨ Fig. **B**

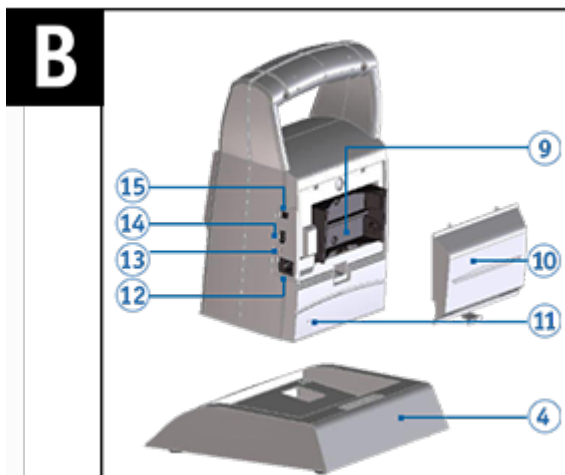

- ▶ Open the battery compartment flap **10** at the rear of the marking device.
- ▶ Place the textile tape evenly over the battery compartment. Insert the batteries observing the **correct polarity**.
- ▶ Close the battery compartment flap **10** again.

### 4.1.1.2 Charging rechargeable batteries

- ▶ Connect the mains adapter of the device to the connection socket provided for the mains adapter **12** and connect it to the mains, **or** connect the device to a running PC by micro USB **14**. The green charging indicator **13** lights up during the charging process. Charging is complete when the **charging indicator 13** is off.

### 4.1.2 ON/OFF function

**i** The jetStamp 990 **does not have a typical power button**, but is switched on and off via defined **button functions**.

This function is only available for devices manufactured from (QC) 12/2025 and serial numbers from (S/N) 6000. You will find the relevant information on the [type plate](#) of the device.

ON/OFF function ⇒ Fig. **A**

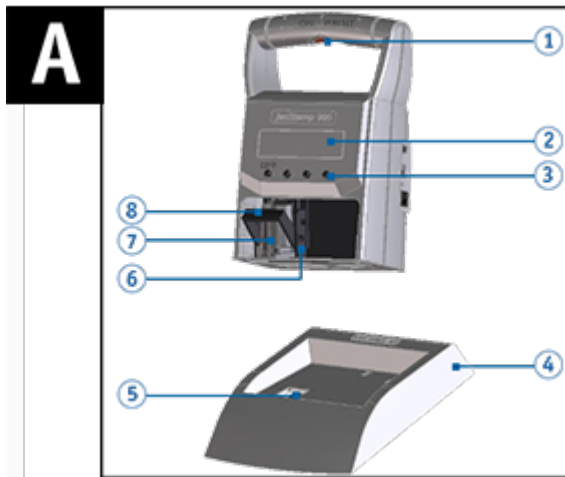

#### **Switch on the device:**

- ▶ Press the **1** trigger button for approx. 1 second. Also see [operating elements](#).  
The device performs a brief **reset**.  
The **display 2** is **active** and shows the last set print image.  
The device is **operational**.

#### **Switch off the device:**

- ▶ In the **3** keypad, press and hold the leftmost button for approx. 1 second. Also see [display and button function](#).  
The **display goes dark**.  
The device is now **switched off**.

### 4.1.3 Inserting the print cartridge

**i** On delivery, the device is set to print cartridge type P1-S-BK by default!  
The print cartridge is delivered separately from the device. If you have ordered a different type of print cartridge, it must be selected accordingly on the device in the device settings. See also ["Settings" - "Cartridge type"](#).

**i** When using quick-drying inkjet print cartridges (MP), please follow the enclosed operating and storage instructions in the print cartridge packaging.

**⚠ CAUTION**

Damage to health caused by ingestion of ink.

- ▶ Do not swallow!
- ▶ Keep the print cartridge out of the reach of children!

Inserting the print cartridge ⇒ Fig. **A** + **C** + **E**

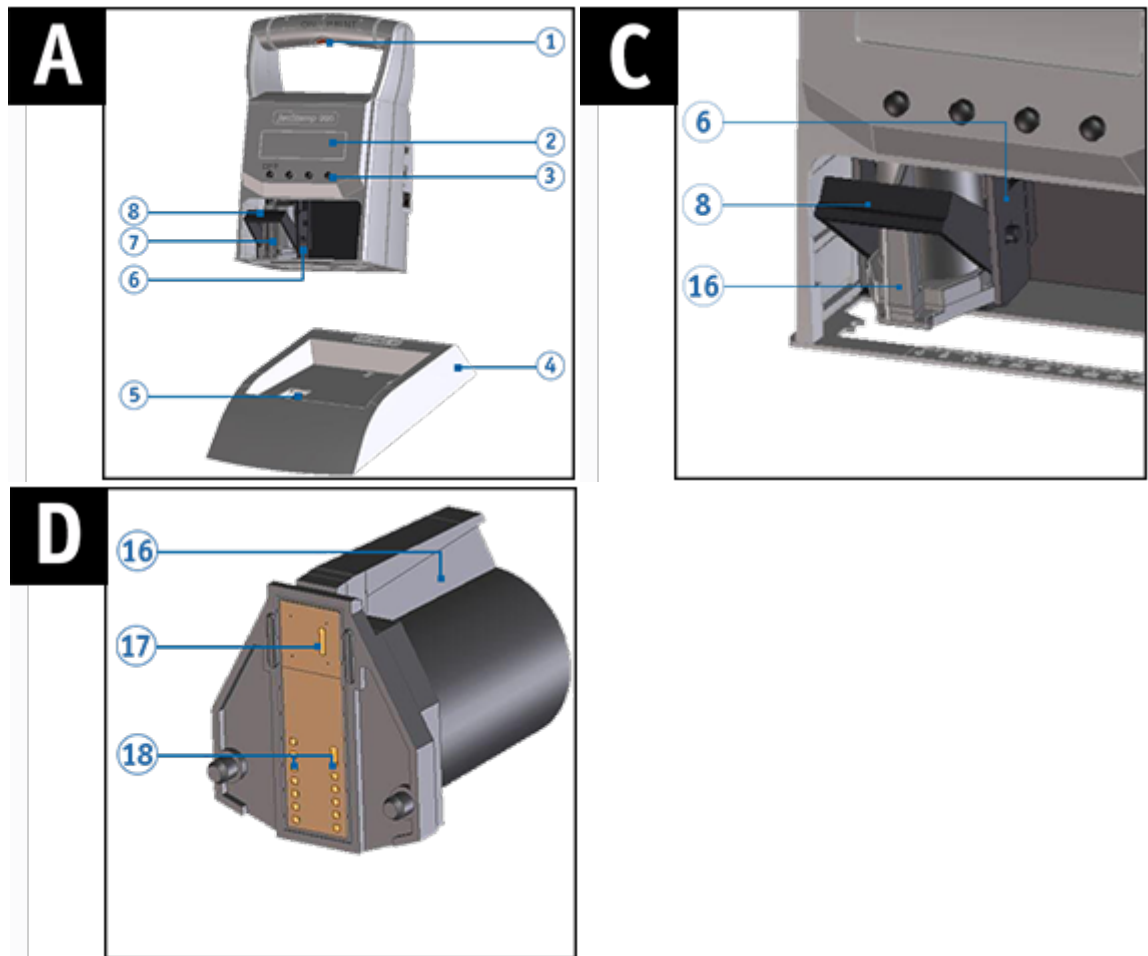

- ▶ Take the *jetStamp* 990 from the basis station **4**.
- ▶ Press [MENU].  
"Cartridge change Start" appears on the display.
- ▶ Press [SELECT].  
Print carriage moves to the device centre.  
"Cartridge change end" appears on the display.
- ▶ Open the locking bracket **8** and push it upwards into the rearmost position.
- ▶ Unpack the new print cartridge **7** and remove the protective film or clip.  
(see operating instructions for the print cartridge P1).
- ▶ Hold the print cartridge **7** by the grip strip **16** and insert it into the print carriage **6**.
- ▶ Pull the locking bracket **8** forward again.
- ▶ Press [SELECT].  
The print carriage moves to its basic position.

- ▶ In order to get right to the next menu item, push ◀ ▶.
- OR -
- ▶ To leave the main menu, push [RETURN].  
The selected print image appears.

## 4.2 Setting date and clock time

 See the device settings, under "[Date/Time](#)".

- ▶ Push [MENU] and browse ◀ ▶ until the display shows "Date/Time".
- ▶ Press [SELECT].  
"Change clock" appears.
- ▶ Press [SELECT].

Display: **yyyy mm dd hh mm**

- ▶ The year "**yyyy**" flashes; push ◀ ▶ in order to set the year.
- ▶ Press [OK].
- ▶ The month "**mm**" flashes; push ◀ ▶ in order to set the month.
- ▶ Press [OK].
- ▶ The day "**dd**" flashes; push ◀ ▶ in order to set the day.
- ▶ Press [OK].
- ▶ The hours "**hh**" flash; push ◀ ▶ to set the hours.
- ▶ Press [OK].
- ▶ The minutes "**mm**" flash; push ◀ ▶ in order to set the minutes.
- ▶ Press [OK].  
"Change clock" appears again.
- ▶ Push [RETURN].  
[Date/Time] appears.
- ▶ In order to get right to the next menu item, push ◀ ▶.  
– OR –
- ▶ In order to save the settings and leave the menu,  
Press [RETURN] twice.  
The selected print image appears.

## 4.3 Set Summertime

 See the device settings, under "[Date/Time](#)" - "[Summertime \(summer time interval\)](#)".

- ▶ Push [MENU] and browse ◀ ▶ until the display shows "Date/Time".
- ▶ Push [SELECT] and browse ◀ ▶ until the display shows "Summertime".
- ▶ Press [SELECT].
- ▶ The display "Europe" is flashing. Push ◀ ▶ to get to the display "America" or "None" and make your selection.
- ▶ Push [OK] to save.

- "Summertime" appears.
- ▶ Push [RETURN].
- "Date/Time" appears.
- ▶ In order to get right to the next menu item, push ◀ ▶.
- OR –
- ▶ In order to save the settings and leave the menu, Push [RETURN] twice.
- The selected print image appears.

## 4.4 Printing the print image

### WARNING

Possible blindness due to eye contact with ink.

- ▶ Do not point the *jetStamp* 990 nozzles  against people's faces!

Printing the print image ⇒ Fig. **A** + **D**

 The *jetStamp* 990 is delivered with several pre-programmed sample print images, see [Saved print images](#).

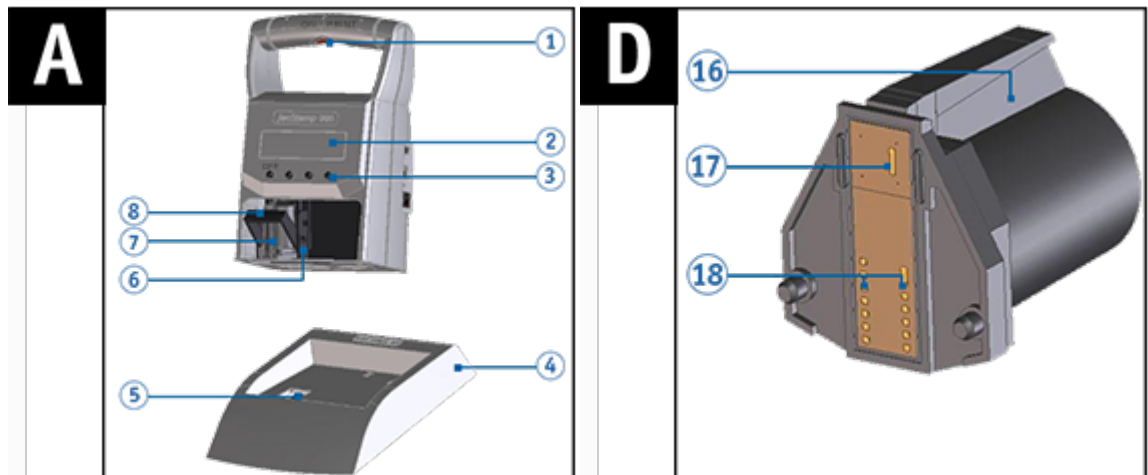

- ▶ Setting the desired print image (see "[Selecting the print image](#)").
- ▶ Place the device on a surface to be printed.
- ▶ Push the trigger button .
- The selected print image is printed.

## 4.5 Saved print images

Up to 25 print images (P01 to P25) can be stored in the device.

P01 to P09 are print images pre-set in the factory. They contain individually print fields such as "Text", "Numbering machine", "Date/time". They can also be set anew or changed.

The active print image is displayed at the upper left of the display, e.g. P09.

[Overview of factory-stored print images](#)

### 4.5.1 Overview of factory-stored print images

Print image P01 = text + current date + time

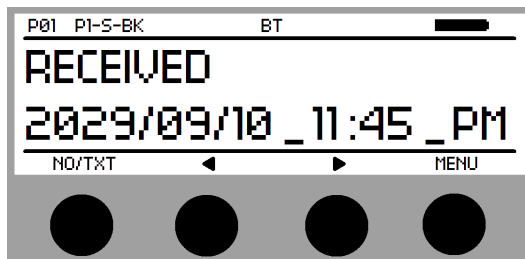

Print image P02 = text + current date and text + pre-dated date)

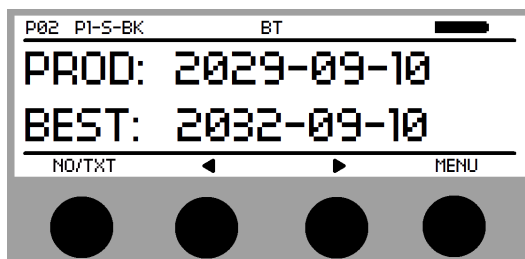

Print image P03 = text + current date and text

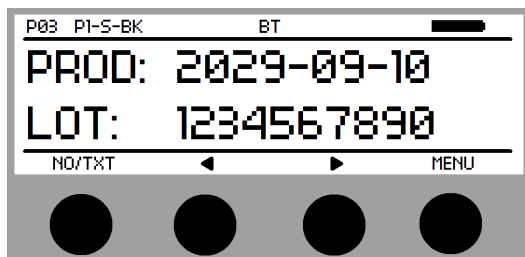

Print image P04 = current date

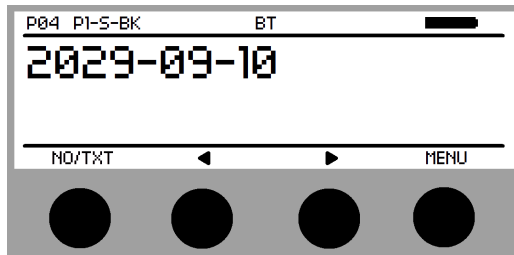

Print image P05 = numbering machine

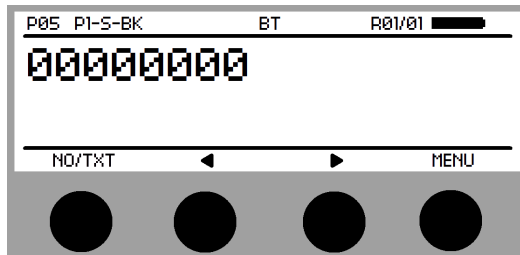

Print image P06 = four texts for editing (font = Western Europe)

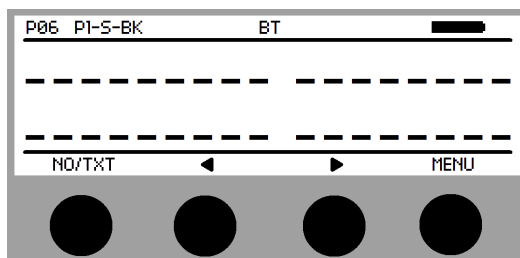

Print image P07 = four texts for editing (font = Western Europe)

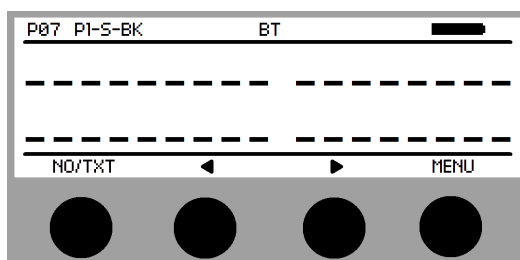

Print image P08 = four texts for editing (font = Cyrillic)

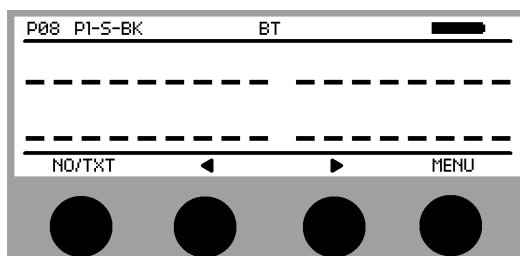

Print image P09 = four texts for editing (font = Greek)

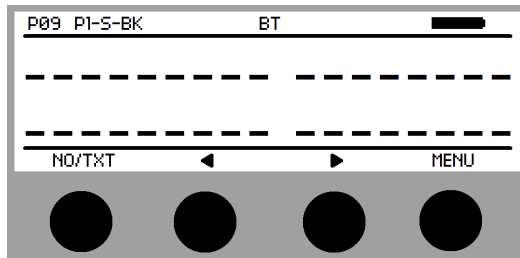

## 4.6 Selecting print image

In order to make settings at the print images, they need to be selected or activated first.

- ▶ Browse ◀ ▶ until the desired print image appears on the *jetStamp* 990.

## 4.7 Edit print image with hotkey function

**i** Only print images that have been printed on the *jetStamp* 990 can be edited.

There are two ways to edit your print image on the *jetStamp* 990 individually:

[Edit text](#)

[Edit numbering machine](#)

### 4.7.1 Edit text

**i** "Num/Text edit" must be set as a hotkey to edit the text, see "[Hotkey](#)".

- ▶ Select the print image to be edited with ◀ ▶.
- ▶ press [NO/TXT].
- ▶ Use ◀ ▶ to select the desired text.
- ▶ Press [SET]
- ▶ The first character can be changed with ◀ ▶. Letters, numbers or special characters are available for selection.
- ▶ Press the [NEXT] button to confirm the input.
- ▶ Once the desired text has been entered, press the [RETURN] button twice.

### 4.7.2 Edit numbering machine

**i** "Num/Text edit" must be set as a hotkey to edit the numbering machine, see "[Hotkey](#)".

- ▶ Select the print image to be edited with ◀ ▶.
- ▶ press [NO/TXT].
- ▶ Use ◀ ▶ to select the desired numbering machine.

With reset, the selected numbering machine is reset to the original value. The original value is the minimum value for numbering machines that are counting up and the maximum value for numbering machines that are counting down.

- ▶ Press [RESET].  
The display shows "Really?". This is a safety query to confirm whether this numbering machine should really be reset.
- ▶ Press [OK].  
the display shows the reset numbering machine.

With "Value", the value of the numbering machine can be changed:

- ▶ Press [SET].  
The first number flashes and can be changed with ◀ ▶.  
The numbers from 0 - 9 can be selected.
- ▶ Press [Next]  
The next digit of the numbering machine can now be changed.
- ▶ Once the desired value has been selected, press the [RETURN] button twice  
The selected print image appears.

- Or -

Push [RETURN].  
to cancel the operation.

 See "Software application 990 PCset", "[Settings Objects - Numbering Machine](#)".

## 4.8 Activate Bluetooth

 Only model 990-001 is Bluetooth capable.

 Bluetooth cannot be activated while an USB connection is active.

 If Bluetooth is active the battery runtime reduces since Bluetooth is active in standby mode as well.

- ▶ Select the button [MENU]. Use the buttons ◀ ▶ to browse until the display shows "Bluetooth".
- ▶ Selecting [SELECT] activates Bluetooth.
  
- ▶ To establish the Bluetooth connection with the device, follow the instructions "[Establishing Bluetooth connection](#)".[Bluetooth-Verbindung-herstell2](#)".

## 4.9 Installing the REINER PCset software

 The installation must be carried out on a commercially available local PC.  
A virtualised PC or thin client is not suitable.

 The local time Furtwangen is preset at delivery of the device.  
Once the device is connected to a PC with the PCset graphic software and a print image is then transferred to the device, the device adopts the local time (see "[Transferring print images](#)").

[System requirements](#)

[Installing the software](#)

## 4.9.1 System requirements

### Supported REINER devices

- *jetStamp* 990

### Hardware

- PC with Pentium CPU (or compatible) or higher
- Graphics adapter with a min. resolution of 800 x 600 pixels (at least 256 colours; optimal: TrueColor, 24 bit, 16,78 million colours)
- Memory 32 MB min.
- 10 MB free hard disk space
- 1 free USB interface

### Supported operating systems

- Windows 7, Windows 7 64 Bit, Windows 8, Windows 8 64 Bit, Windows 10, Windows 10 64 Bit, Windows 11

## 4.9.2 Installing the software

Administrator rights on the PC are required for the installation.

- ▶ Insert installation medium (USB stick or CD) in the PC.
- ▶ If the installation program does not start automatically, start the file "**Setup\_PCset.exe**".
- ▶ Follow the instructions of the installation program.

 The software can also be downloaded from our website at [www.reiner.de](http://www.reiner.de).

## 4.10 Firmware update

The latest firmware for the *jetStamp* 990 can be downloaded from the REINER website, [www.reiner.de](http://www.reiner.de), in the [downloads](#) section.

 Uploading print images that were not saved on the PC (see "[File](#)"). Ensure that the REINER PCset is installed on your PC but **not** opened before the firmware update is started. While the firmware update is being installed, the *jetStamp* 990 must not be switched off or removed from the supply voltage.

- ▶ Connect the mains socket  to the supply voltage via the mains adapter.

- ▶ Connect the micro USB socket  to the PC via the USB cable.
- ▶ Unpack "**Firmware Update**" and start "**jetStamp990\_Firmware\_xxxx.exe**". The firmware is installed automatically. After a successful firmware update, the REINER PCset can be opened again.

## 5 Software application 990 REINER PCset

[Preparing the jetStmap 990 for REINER PCset](#)

[Starting the REINER PCset software](#)

[Operating interface](#)

[Establishing Bluetooth connection](#)

[Example workflow: Generating the print image](#)

[Objects settings](#)

### 5.1 Preparing jetStamp 990 for REINER PCset

Preparing the *jetStamp* 990 for REINER PCset ⇨ Fig. **B**

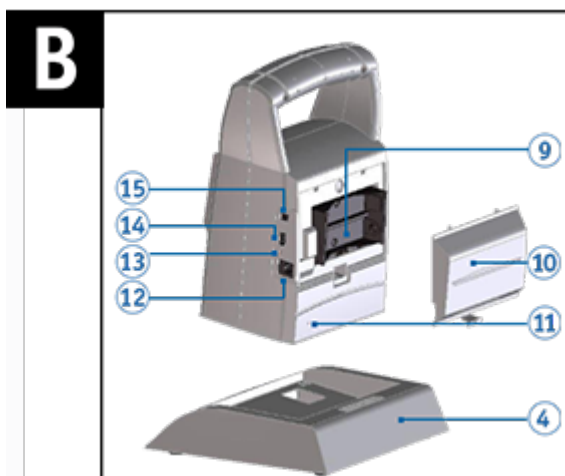

**i** The PC can only recognise the device correctly if the REINER PCset is installed first. Find more on this under: [Installing the software](#).

- ▶ Double-click the **REINER PCset icon**  .  
The REINER PCset software is started.
- ▶ Connect the Micro USB socket **14** to the PC via the USB Bluetooth cable.  
The PC recognises the *jetStamp* 990 as a new USB device.  
The device driver software is installed automatically.

### 5.2 Starting the REINER PCset software

- ▶ Double-click the **REINER PCset icon**  .  
The REINER PCset software is started.

## 5.3 Operating interface

The operating interface is divided into four sections:

- a) Menu bar
- b) Toolbar
- c) Register 1 - 25, (\*) at the tab indicates existing print image, (print image P01 - P25)
- d) 2 lines for design of the print images
- e) Status indicators

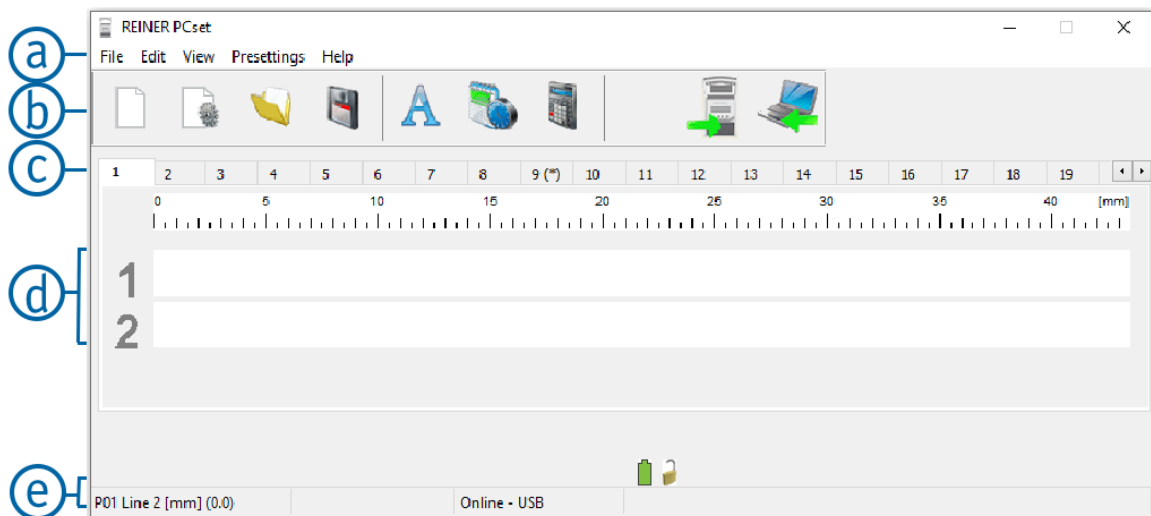

### 5.3.1 Menu bar

In addition to the functions in the tool bar **b**, you can find a menu bar **a** in the REINER PCset application.

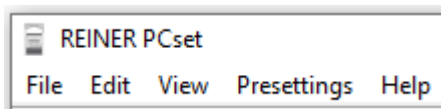

In the menu bar you will find both common, self-explanatory standard commands as well as REINER PCset -specific menu commands.

[File](#)

[Edit](#)

[View](#)

[Presettings](#)

[Help](#)

### 5.3.1.1 File

Function	Description
New	Reset the display. Delete the displayed draft.
Open	File selection menu for loading previously saved print images.
Save	Save the displayed print image as RPS file.
Save as	The dialogue for saving the print images appears.
Device settings date/time/numbering machine	Configure the date/time and numbering machine.
Transferring the print images	Print images are transferred to the device.
Upload print images	The print images are uploaded onto the PC.
Find REINER Bluetooth devices	Searches for REINER Bluetooth devices.
Last opened	Displays the last opened print images.
Exit	Ends the REINER PCset.

### 5.3.1.2 Edit

Function	Description
Delete	Deletes selected objects.
Copy	Load selected content to the clipboard.
Paste	Paste content from the clipboard.
Cut	Delete selected contents.

### 5.3.1.3 View

Function	Description
Language	Setting language: German, English, French, Spanish, English (Cyrillic CP 855), English (Greek CP 869)
Unit	Pixel, mm, inch

### 5.3.1.4 Presettings

 Settings are PC-specific.

The settings (properties of text, date/time, and numbering machine objects) are generally valid. These settings are accessible for all users.







Function	Description
Text	Settings for text objects can be configured.
Date/Time	Settings for date/time objects can be configured.
Numbering machine	Settings for numbering machine objects can be configured.

### 5.3.1.5 Help

Function	Description
Help	Calling up the online help.
Info	Information on REINER PCset and connected <i>jetStamp 990</i> .

### 5.3.2 Toolbar





Objects can be pulled into the line by drag & drop.  
An imprint may have up to two lines and up to 20 characters per line.

Toolbar 	Command	Description
	New	Reset the display. Delete the displayed draft.
	Device settings date/time/numbering machine	Configure the date/time and numbering machine.
	Open	File selection menu for loading previously saved print images.
	Save	Save the displayed print image as RPS file.
	Transfer	Print images are transferred to the device.
	Upload	The print images are uploaded onto the PC.

### 5.3.3 Objects

Print images are composed of objects from the object groups described below. Objects can be placed freely using drag & drop (see "[Example Workflow: Generate Print Image](#)").



 Double-click or right-click the symbols in the tool bar  to call further settings.

Toolbar 	Command	Description
	Text	The text in the text input field is inserted into the lines of the print image by drag & drop of the text object.
	Date/Time	A date/time object can be placed either in the first or the second line. One date/time object per line is permitted. The calendar data of the different date objects can be set deviating from each other.
	Numbering machine	A numbering machine object can be placed either in the first or the second line. The numbering machine is used for sequential numbering.

## 5.4 Establishing Bluetooth connection

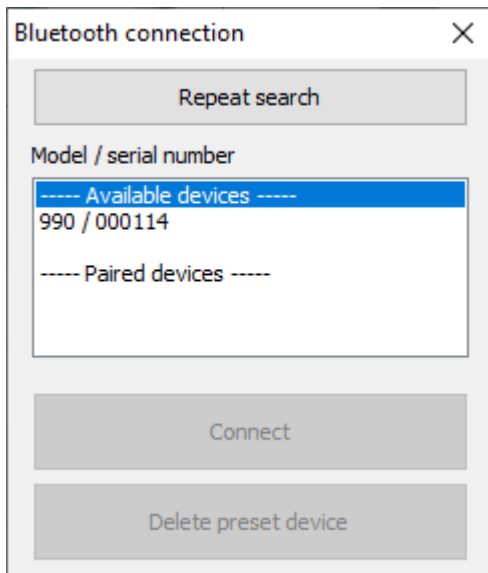
- ▶ To establish a Bluetooth connection, Bluetooth must be activated on the device (see "[Activate Bluetooth](#)").
- ▶ Opening the REINER PCset.
- ▶ In the menu bar  select the "File" tab and click "Search for REINER Bluetooth devices".  
An automatic search is started.  
All devices found, all paired devices, as well as all devices that have already been connected to the REINER PCset, are displayed with model and serial number.
- ▶ If the *jetStamp 990* is not found, a new search run can be started with the "Search again" button.  
Note that Bluetooth must be activated on the device for this!  
The status line in the device must show "BT" for this.



- ▶ To establish the Bluetooth connection, select the corresponding device in the list and click "Connect".  
A pop-up menu "Connection via Bluetooth device" opens in the Windows status bar.
- ▶ After a short time the *jetStamp 990* is connected to the REINER PCset.
-  The connected device is saved as a permanent connection so that the REINER PCset always connects to this device as soon as it is available.
-  When REINER PCset is connected to the *jetStamp 990*, the device display shows BTC.
- ▶ To cancel the permanent connection, click the "Delete pre-set device" button in the Bluetooth dialogue or establish a connection with another device.

## 5.5 Example workflow: Generating the print image

- ▶ Click the **Upload symbol**  to upload the print images of the *jetStamp 990* on the PC.

- ▶ Change the desired print image (see [Configuring the print image](#)).
- ▶ Click the **transfer symbol**  to transfer the print images to the device (see [Printing the print image](#)).







[Configuring the print image](#)

[Transferring the print image to jetStamp 990](#)

[Printing the print image](#)

## 5.5.1 Configuring the print image

### Inserting text, date/time, or numbering machine

- ▶ To create a text object, left-click on the **text symbol**  in the tool bar,  drag it to the desired line and position and drop it there.
- ▶ Write the desired text into the text field and accept with OK.  
- Or -
- ▶ In order to create a date/time object, left-click the **date/time symbol**  in the tool bar,  drag it to the desired line and position and drop it there.  
- Or -
- ▶ To create a numbering machine object, left-click on the **numbering machine symbol**  in the tool bar,  drag it to the desired line and position and drop it there.

 For further commands, see "[Toolbar](#)".

## 5.5.2 Transferring the print images

All present print images are transferred in every case. A single print image cannot be transferred.

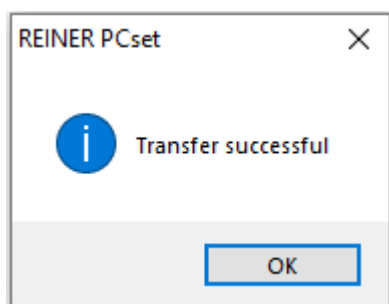

- ▶ Click on the **transfer icon** .  
After successful transfer, the following message appears after a few seconds:



The print images are saved in the *jetStamp* 990 and can now be printed.

## 5.6 Objects settings

 Pull the symbols for text , date/time, , and numbering machine  into the line simply and quickly by drag & drop.

 Right-clicking the symbols (see "[Objects](#)") in the tool bar  calls up further settings. The settings of a single object can also be changed subsequently by right-clicking on it and then choosing Edit.

The settings of the objects can also be selected in the menu bar  by clicking the "Presettings" tab or via the context menu.

[Text](#)

[Date/Time](#)

[Numbering machine](#)

### 5.6.1 Text



Creates text fields.

When a text object is inserted, the configuration corresponds to the "presettings". Each one can be changed individually via the "context menu text object".

- ▶ Click the symbol for the **text** , hold the mouse button down, drag it to the desired line/position and release the mouse button.
- ▶ The configuration window for "Text" opens (see [Presettings](#)).

[Presettings](#)

[Context menu text object](#)

#### 5.6.1.1 Presettings

Changed presettings apply to all future text objects.

- ▶ In the menu bar  select the "Presettings" tab and click "Text".  
The configuration window for "Text" opens as shown in the following figure:

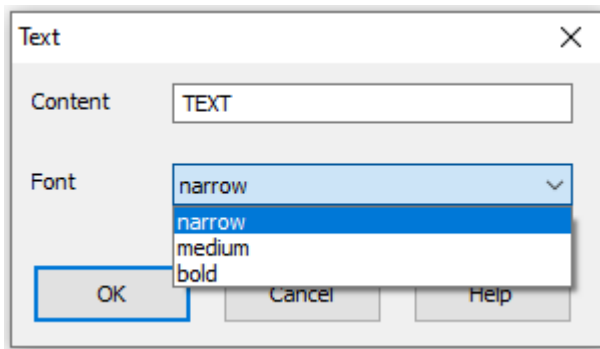

Function	Description
Contents	Enter the desired text.
Font	Selection option: narrow, medium, bold.

### 5.6.1.2 Context menu text object

- ▶ To open the context menu, right-click the desired text object.  
The context menu opens as in the following figure:

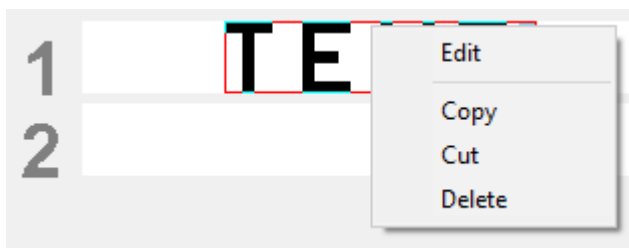

Function	Description
Edit	Object becomes active and can be edited.
Copy	Copies the object.
Cut	Cuts out the object.
Delete	Deletes the object.

**i** Enter or double-click fixes the object, which then can no longer be edited.

## 5.6.2 Date/Time



Creates the format of date and time.

When a date/time object is inserted, the configuration corresponds to the presetsings". Each date/time object can be changed individually via the context menu.

- ▶ Click the symbol for the **date/time** , hold the mouse button down, drag it to the desired line/position and release the mouse button.
- ▶ The configuration window for "Date/time" opens (see [Presettings](#)).

[Presettings](#)

[Context menu date/time object](#)

### 5.6.2.1 Presettings

Changed presetsings apply to all future date/time objects.

- ▶ In the menu bar  select the "Presettings" tab and click "Date/time". The configuration window for "Date/time" opens as shown in the following figure:

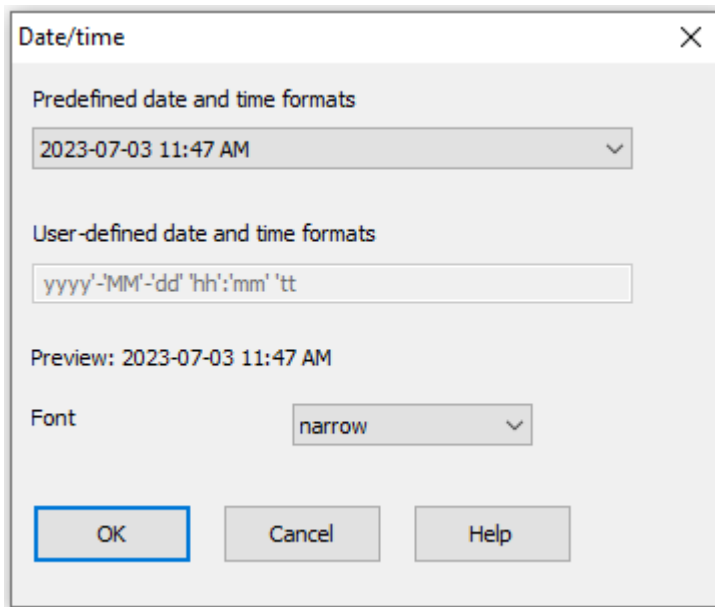

Function	Description
Predefined date and time formats	List of preconfigured formats. Selection by clicking.
User-defined date and time formats	Shows the selected format in the draft view. The format can be manually configured.

	<p>One abbreviation of a category each from the following table "Format abbreviation" can be used once.</p> <p>Additional characters (also spaces) are inserted by being included in simple apostrophes (').</p> <p>For verification, the text is written in "red" once the entered format is no longer OK.</p>
Preview	Preview of the selected format with the current system date.
Font	Selection option: narrow, medium, bold.

**Format abbreviation**

Function	Description
dd	Day of the month with two figures (01 to 31)
ddd	Calendar day with three figures (001 to 365) Example: 28 May 2019 = 148.2019
MM	Month of the year with two figures (01 to 12)
MMM	Abbreviation for the month (up to 3 characters)
yy	The last two figures of the year (00 to 99)
yyyy	Complete year (0000 to 9999)
HH	Hour with two figures (00 to 23)
hh	Hour with two figures (01 to 12)
mm	Minutes with two figures (00 to 59)
ss	Seconds with two figures (00 to 59)
t	One character for twelve-hour format with the letters A or P
tt	Two characters for twelve-hour format with the letters AM or PM
cc	Calendar week with two digits (1 to 53)
w	Day of the week with one digit (1--7) 1 = Monday, 2 = Tuesday, .....7 = Sunday

[Tab File - Settings Date / Clock time](#)

5.6.2.1.1 Tab File - Settings Date / Clock time

- ▶ Click the tab "File" to open the dialogue "Settings Date/time/numbering machine".

A dialogue opens as in the following figure:

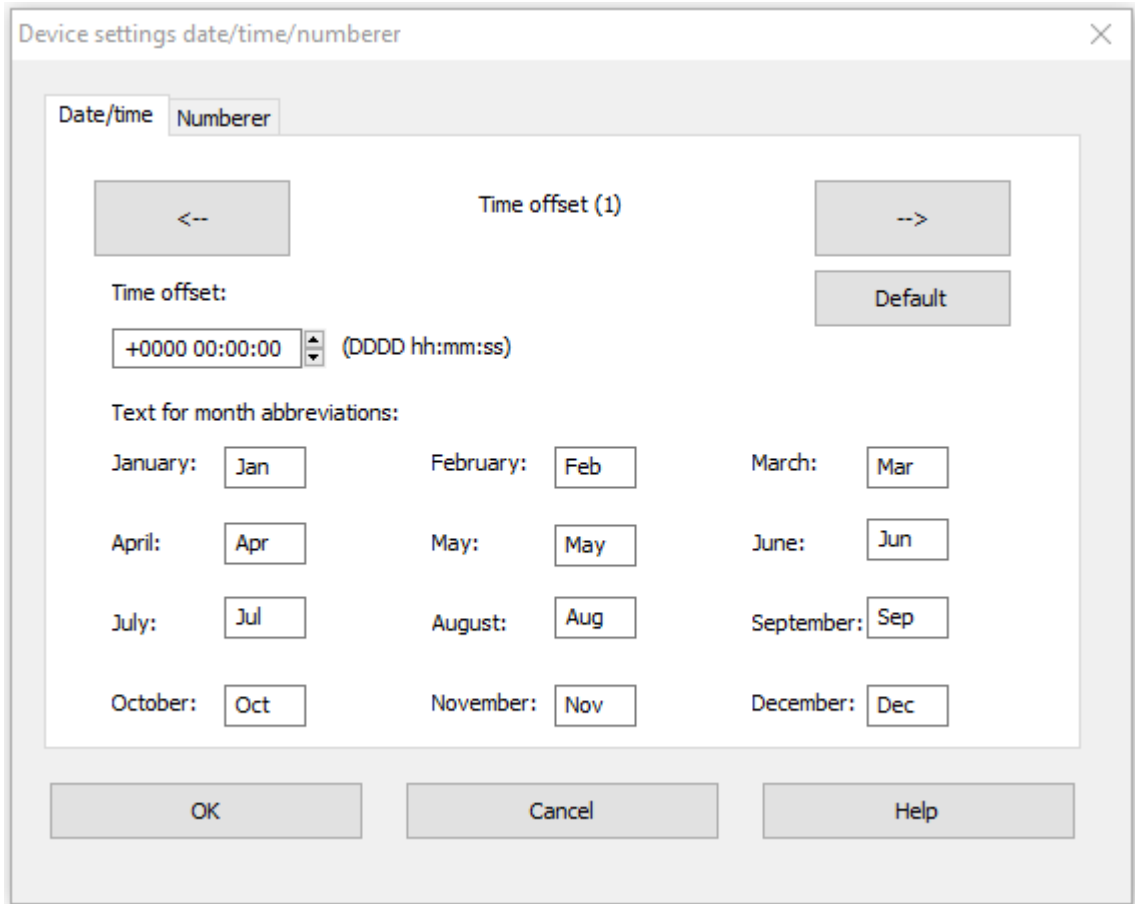

Function	Description
Standard	The set values are reset to default.
Time offset	The configuration of an offset for date and time can be used, for example, to automatically calculate expiration dates. Enter or select offset. The time offset has the format TTT hh:mm:ss. The set values are added to the current system date. Up to 4 offsets can be set up ("Date/time number 1" to "Date/time number 4").
Text for the month abbreviations	Abbreviation for the month abbreviations (3-digits)

### 5.6.2.2 Context menu date/time object

When a date/time object is inserted, the configuration corresponds to the presettings. Each date/time object can be changed individually via the context menu.

- ▶ To open the context menu, right-click the desired date/time object.

The context menu opens as in the following figure:

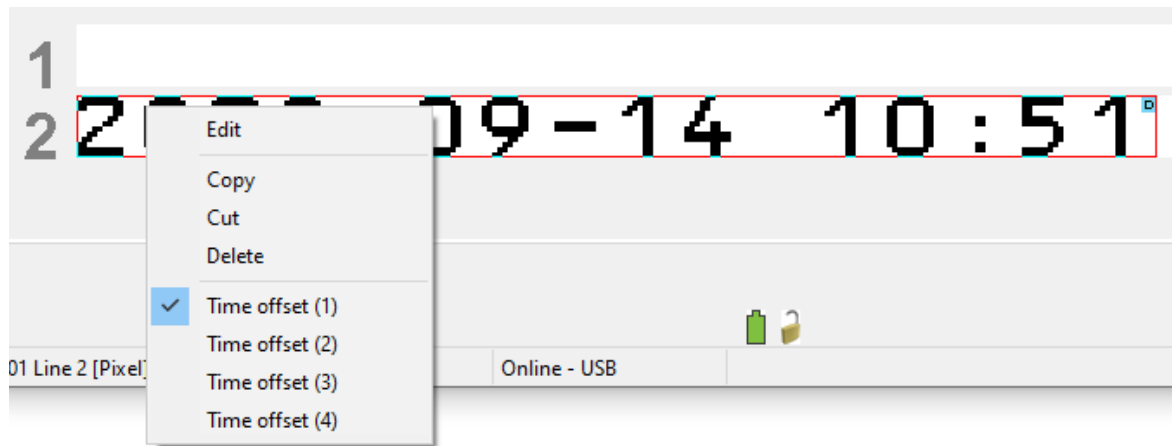

Function	Description
Edit	Opens the configuration window for date and time for the selected date/time object.
Copy	Copies the object.
Cut	Cuts out the object.
Delete	Deletes the object.
Time offset (1 to 4)	Select previously specified time offset ( <a href="#">Tab File - Settings Date/time</a> ).

### 5.6.3 Numbering machine



The numbering machine is used for sequential numbering.

When a numbering machine object is inserted, the configuration corresponds to the presettings".

Each one can be changed individually via the "Context menu numbering machine".

**i** The minimum length is 1 character; the maximum length is 8 characters.

- ▶ Click the symbol for the **numbering machine** , hold the mouse button down, drag it to the desired line/position and release the mouse button.  
The configuration window for "Numbering machine" opens (see [Presettings](#)).

[Presettings](#)

[Context menu numbering machine object](#)

### 5.6.3.1 Presettings

Changed presettings apply to all future numbering machine objects.

- ▶ In the menu bar  select the "Presettings" tab and click "Numbering machine".  
The configuration window for "Numbering machine" opens as shown in the following figure:

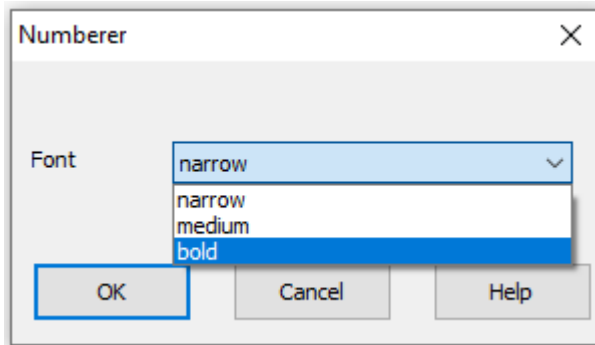

Function	Description
Font	Selection option: narrow, medium, bold.

[Tab File - Settings Date / Clock time](#)

5.6.3.1.1 Tab File - Settings Date/time/numbering machine

- ▶ Click the tab "File" to open the dialogue "Settings Date/time/numbering machine" and then click "Numbering machine".  
A dialogue opens as in the following figure:

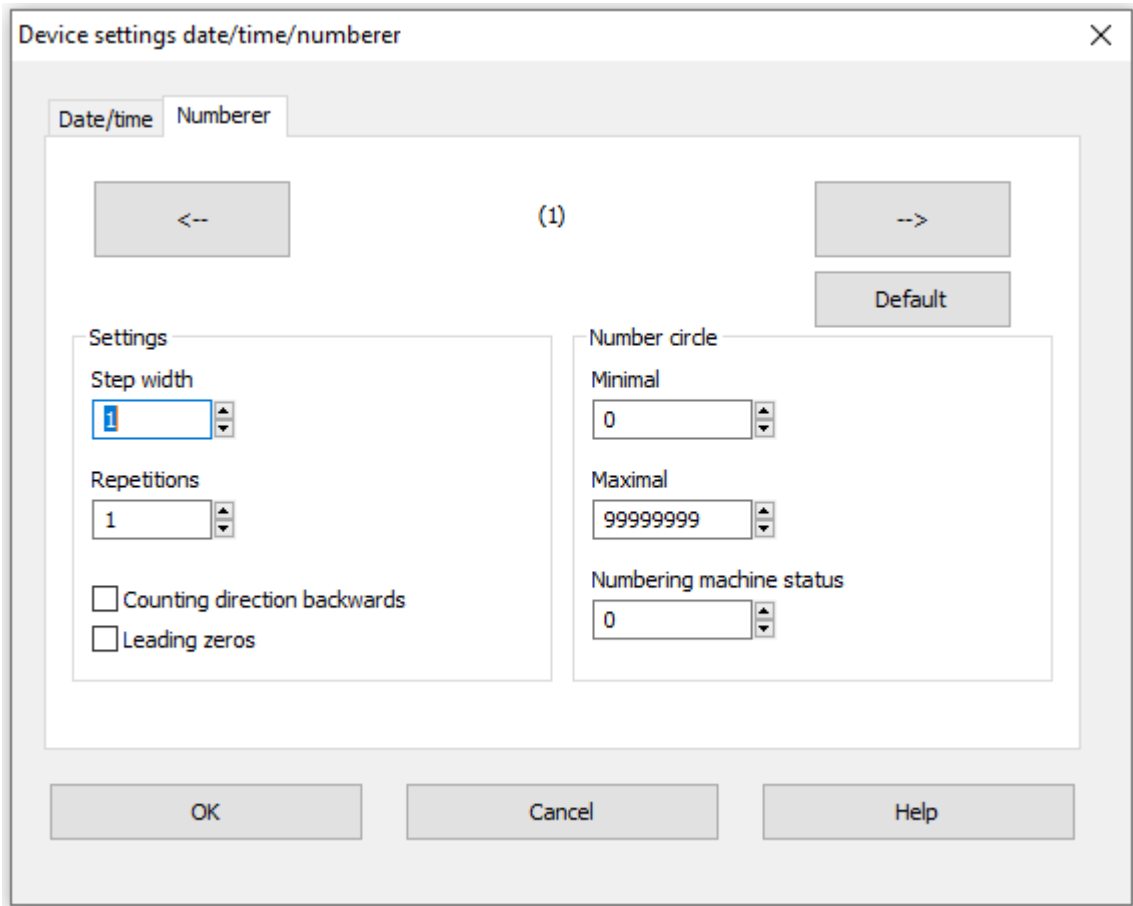

**Numbering machine settings**

Function	Description
Standard	The set values are reset to default.
Step	Indicates the interval at which the numbering machine counts on (e.g. 1,4,7... in steps of 3). The step width can be set from 1 to 65535.
Repetitions	Indicates the number of repetitions of a print image. If, e.g., the value 3 is set, the numbering machine remains on the same number for three imprints before it counts on. The repeat factor can be set from 1 to 65535.
Counting direction backwards	The numbering machine can count up (e.g. 10,11,12,...) or backwards (e.g. 10,9,8...).
Pre Zeros	Leading zeros can be suppressed or printed (e.g. 5 or 0000005). The number of printed figures depends on the maximum value set at "number circle".

## Number circle

The number circle defines the value range in which a numbering machine counts.

When the maximum or minimum value is reached (for upwards or downwards counting numbering machine), the count is continued at the respective other end of the scale.

Function	Description
Minimum	This value marks the lower limit of the number circle and thereby at the same time determines the number of digits to be printed if leading zeroes are activated.
Maximum	This value marks the upper limit of the number circle.
Numbering machine status	The current counter reading can be set within the defined value range.

### 5.6.3.2 Context menu numbering machine object

When a numbering machine object is inserted, the configuration corresponds to the presettings. Each numbering machine object can be changed individually via the context menu.

- ▶ To open the context menu, right-click the desired numbering machine object.

The context menu opens as in the following figure:

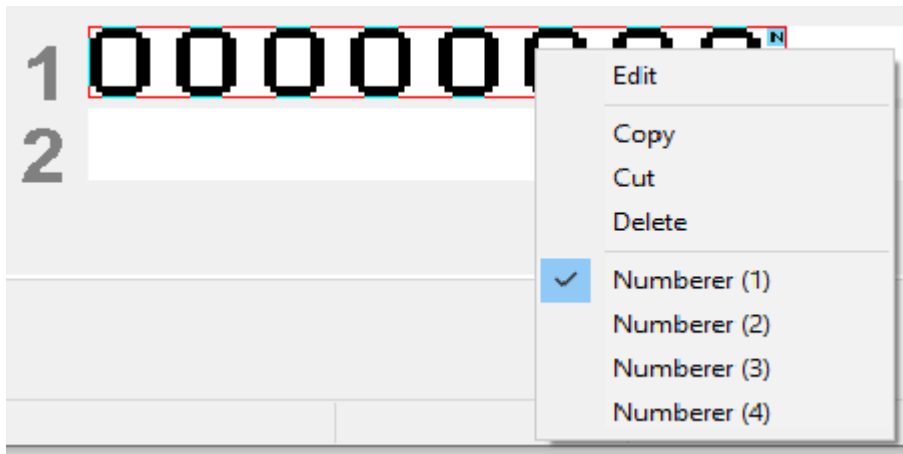

Function	Description
Edit	Opens the configuration window for the selected numbering machine object.
Copy	Copies the object.
Cut	Cuts out the object.
Delete	Deletes the object.
Numbering machine (1 to 4)	Select previously specified numbering machine ( <a href="#">Tab File - Settings Date/Time - Numbering Machine</a> ).

## 6 Maintenance

[Changing the print cartridge](#)

[Cleaning the contacts of the print cartridge](#)

[Clean nozzles](#)

[Clean print carriage](#)

[Clean housing](#)

### 6.1 Changing the print cartridge

**i** When using special ink (MP), observe the notes in the operating instructions for the print cartridge.

#### **CAUTION**

Damage to health caused by ingestion of ink.

- ▶ Do not swallow!
- ▶ Keep the print cartridge out of the reach of children!

Changing the print cartridge ⇨ Fig. **C** + **D**

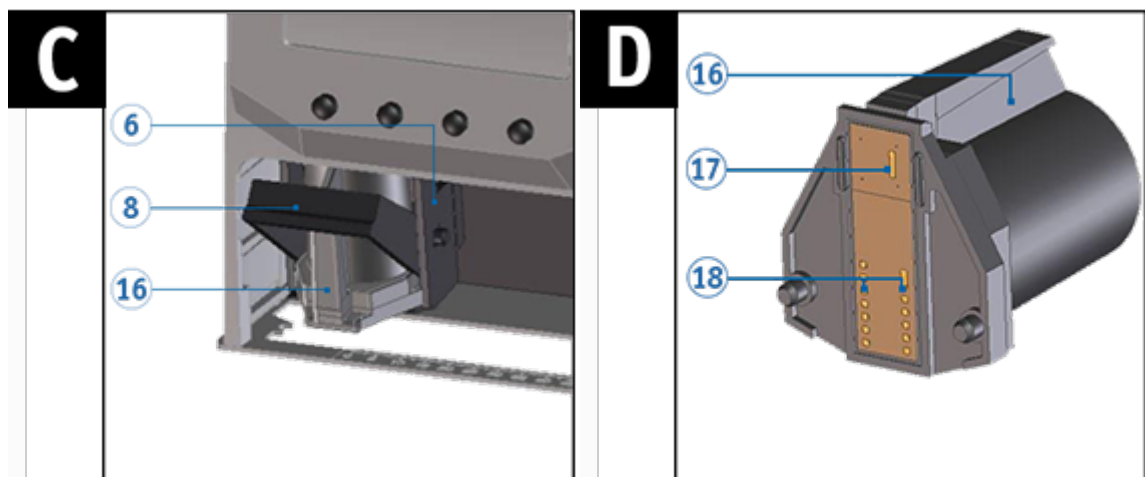

- ▶ Take the *jetStamp* 990 from the basis station **4**.
- ▶ Push [MENU] and browse ◀ ▶ until the display shows "Cartridge change start".
- ▶ Press [SELECT].  
Print carriage moves to the device centre.
- ▶ Push the locking bracket **8** into the rear-most position.
- ▶ Take the print cartridge **7** from the print carriage **6**.
- ▶ Unpack the new print cartridge **7** and remove the protective film or clip.  
(see operating instructions for the print cartridge P1).

- ▶ Hold the print cartridge by the grip strip **16** and insert it into the print carriage **6**.  
Pull the locking bracket **8** forward again.
- ▶ Press [SELECT].  
The print carriage moves to its basic position.
- ▶ In order to get right to the next menu item, push ◀ ▶.
- Or -
- ▶ To leave the main menu, push [RETURN].  
The selected print image appears.

## 6.2 Cleaning the contacts of the print cartridge

Cleaning the contacts of the print cartridge ⇒ Fig. **A** + **C** + **D**

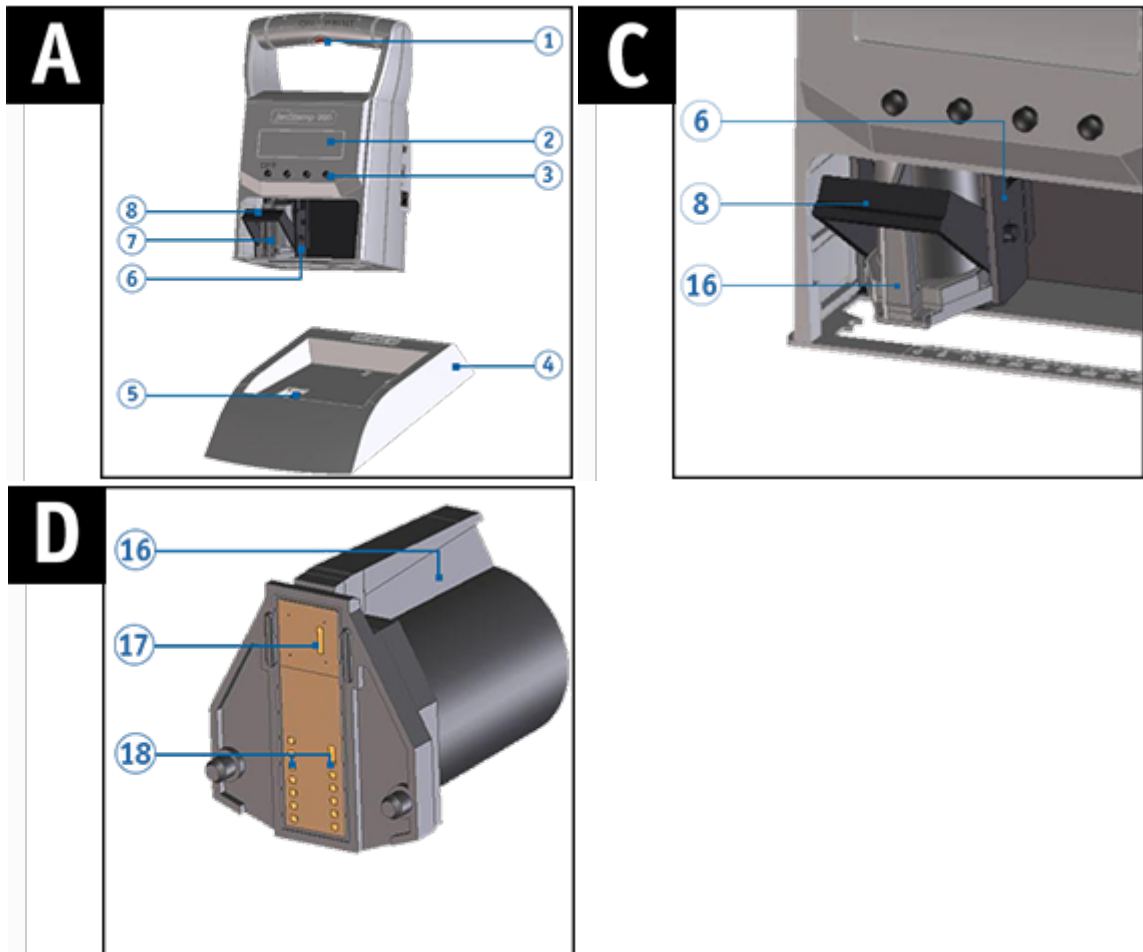

In rare cases, impurities on the contacts of the print cartridge **18** can cause incorrect printing results.

- ▶ Take the *jetStamp* 990 from the basis station **4**.
- ▶ Push [MENU] and browse ◀ ▶ until the display shows "Cartridge change start".
- ▶ Press [SELECT].  
Print carriage moves to the device centre.
- ▶ Push the locking bracket **8** into the rear-most position.
- ▶ Remove the print cartridge **7** from the device.
- ▶ Clean the contacts of the print cartridge **18** at the print cartridge **7** and at the print carriage **6** with a soft cloth slightly soaked in ethanol (spirit) if necessary.
- ▶ Hold the print cartridge by the grip strip **16** and insert it into the print carriage **6**.
- ▶ Pull the locking bracket **8** forward again.
- ▶ Press [SELECT].  
The print carriage moves to its basic position.

## 6.3 Clean nozzles

### WARNING

Possible blindness due to eye contact with ink.

- ▶ Do not point the *jetStamp 990* nozzles **17** against people's faces!

If there are streaks in the imprint or problems with the print quality, the ink may have dried on the nozzles **17**. There are two possible procedures for correction:

[Manual nozzle cleaning](#)

[Maintenance via the "Maintenance" device menu](#)

### 6.3.1 Manual nozzle cleaning

Manual nozzle cleaning ⇔ Fig. **A** + **D**

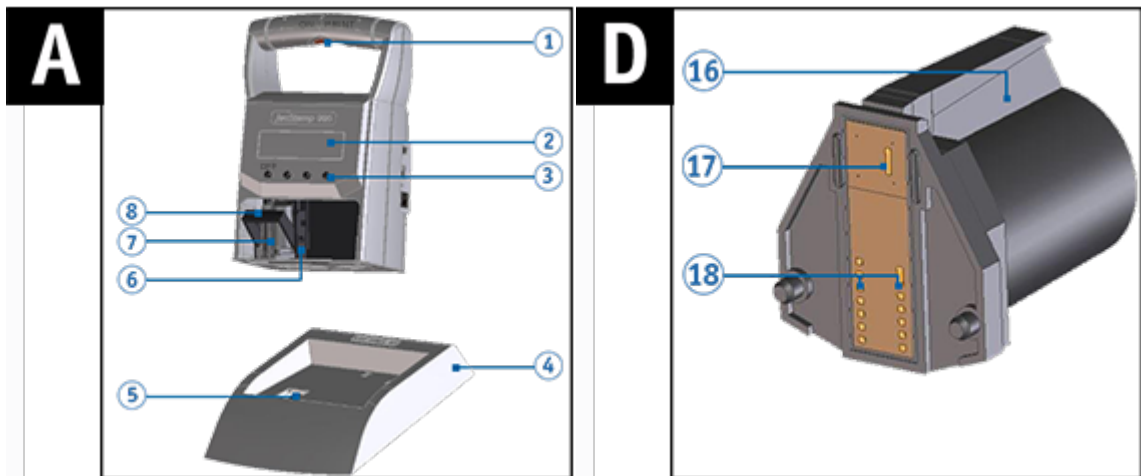

To ensure high print quality, the nozzles should **17** cleaned at regular intervals as follows:

- ▶ To dissolve the dried ink, press a soft cloth slightly soaked in ethanol (spirit) against the nozzles for about three **17** seconds.
- ▶ Dab off dissolved ink and **17** wipe the nozzles dry.

 For further information (also see "[Cleaning the contacts of the print cartridge](#)").

 For notes on temperatures and humidity, see "[Technical Data](#)" in the documents accompanying the print cartridges.

## 6.4 Clean print carriage

Ink and dried-in ink residues at the print carriage are removed with a soft spirit-soaked cleaning rag.

 On this, see also "[Cleaning contacts at the print cartridge](#)".

## 6.5 Clean housing

### CAUTION

Electric shock when liquids enter into the device inside.

- ▶ Pull the mains adapter from the outlet.
- ▶ Inform a specialist vendor or the REINER service.

### NOTICE

Cleaning agents that are too aggressive may damage the housing surface.

- ▶ Do not use any abrasives and plastic-dissolving cleaning agents for cleaning.
- ▶ Clean the top cover of the device with a soft cloth if required.  
For stronger contamination, slightly moisten the cloth with water and mild detergent.

## 7 Recognising and removing interferences

[Warning messages](#)

[Correctable error messages](#)

[Device error messages](#)

### 7.1 Warning messages

Display	Cause	Correction
Imprint too long	Print image too long. Press the [OK] button to confirm.	▶ In PCset: Change the object and re-transfer it to the device.
Imprint wrong format	Wrong print image format. Press the [OK] button to confirm.	▶ In PCset: Change the object and re-transfer it to the device.
No print cartridge	Print cartridge missing. Press the [OK] button to confirm.	▶ Insert print cartridge.
Recharg. battery almost empty	The batteries are almost empty. Press the [OK] button to confirm.	▶ Connect the mains adapter or USB and charge the batteries.
Recharg. battery bad	Poor battery quality	▶ Replace batteries.
Bluetooth init failed	Bluetooth initialisation is missing. Press the [OK] button to confirm.	▶ Repeat.
Print carriage movement blocked	Print carriage blocked. Press the [OK] button to confirm.	▶ Movement of the print carriage was stopped. Repeat.
Bluetooth receive failed	Bluetooth reception failed. Press the [OK] button to confirm.	▶ Repeat.

### 7.2 Correctable error messages

Display	Cause	Correction
Device is locked	Device is locked	▶ Unlock the 990 device in the menu ([Menu] button).
Recharg. battery empty	Rechargeable batteries empty	▶ Connect the mains adapter or USB and charge the batteries.
Recharg. battery missing	Battery compartment empty	▶ Insert batteries.
Recharg. battery very low	The batteries are almost empty	▶ Connect the mains adapter or USB and charge the batteries.
Recharg. battery charging failed	Battery charging failed	▶ Repeat the battery charging process (connect the mains adapter or USB and charge the batteries).

### 7.3 Device error messages

Display	Correction
Device error xx	Reset of device 990 required. Remove the batteries and reinsert them.

## 8 Technical data and accessories

[Type plate](#)

[Technical data](#)

[Transport and disposal](#)

[Accessories](#)

### 8.1 Type plate

 Observe the type plate before the device is connected.

The type plate is located on the underside of the device.  
It contains the following information:

Mod. = Model

S/N = Serial number

QC. = Date of manufacture/Quality control

 = Direct current

 = Polarity of hollow plug

 = Caution when handling rechargeable batteries.

 = Observe the operating instructions.

 = *Batteries may grow hot in case of defects. Never try to remove any hot batteries from the battery compartment.*

 = *jetStamp 990* has the CE-mark according to the currently valid low-voltage and EMC directive.

 = *jetStamp 990* complies with the following standards or standardised documents FCC 47 CFR Ch.1 Part 15 Bluetooth: FCC: R7TAMB2300.

 = do not point the *jetStamp 990* nozzles against people's faces!

 **Waste electrical and electronic devices**  
Old devices must not be disposed of in the common household waste but in a specified acceptance point for recycling of electrical and electronic devices.

## 8.2 Technical data

<b>Technical data</b>	
Dimensions stand-alone unit	101 x 81.45 x 158.95 mm (l x w x h)
Dimensions basis station	115.3 x 143.55 x 32.8 mm (l x w x h)
Total height	177.35 mm
Weight stand-alone unit	approx. 490 g
Weight basis station	approx. 250 g
Stamping time	< 1 second
Stamping sequence	> 3 seconds
Battery capacity	> 2,000 imprints
Printing technology	Inkjet
Ambience temperature for operation	10 °C ... +40 °C
Humidity for operation	10 % ... 80% relative humidity
Temperature for storage	
With standard print cartridges	10 °C ... +40 °C
With MP print cartridges	10 °C ... +20 °C
Storage humidity	10 % ... 80% relative humidity
With print cartridges	
Ambience temperature for transport	-20 °C ... 40 °C (up to 24 hours)
Humidity for <b>transport</b>	10 % ... 90% relative humidity
Data transfer	USB, Bluetooth (optional)
Power supply	2 x AA NiMH rechargeable batteries; chargeable via included mains adapter. Input: 100-240VAC, 50-60Hz, 0.3A Output: 5VDC 1000mA
Standby time per battery charge	approx. 6 days
Battery charging time	approx. 3 hours
Print capacity per print cartridge	approx. 300,000 characters
Noise level	< 60dB (A) (work-related emission value purs. to ISO 7779)
Protection class	IP 20

## 8.3 Transport and disposal

### Transport

#### **NOTICE**

Damage to the device at improper transport.

- ▶ Only use packaging that provides protection from impact and shock for the device!

### Disposal



#### **Defective or flat batteries**

Used batteries or rechargeable batteries must not be disposed of with household waste.



#### **Waste electrical and electronic devices**

Old devices must not be disposed of in the common household waste but in a specified acceptance point for recycling of electrical and electronic devices.



## 8.4 Accessories

### Inkjet print cartridge

- Order no.: 801 307 - 000, P1-S-BK (51604A-B) for paper and cardboard, black
- Order no.: 791 050 - 000, P1-EF-AUB for chicken eggs, aubergine
- Order no.: 791 050 - 001, P1-EF-RD for chicken eggs, red

### Inkjet print cartridge (quick drying)

- Order no.: 791 060 - 020, P1-MP3-BK for metal and plastic, black
- Order no.: 791 060 - 030, P1-MP4-BK for glass, metal and plastic, black
- Order no.: 791 060 - 040, P1-MP6-YE for metal and plastic, yellow

For further accessories, see [www.reiner.de](http://www.reiner.de)

## 9 Contact

### **Ernst Reiner GmbH & Co. KG**

Baumannstr. 16  
78120 Furtwangen/Germany

### **Repair service**

More details can be found on our homepage: [www.reiner.de](http://www.reiner.de)

### **Technical service & support**

Phone: +49 7723 657-388

E-mail: [repair@reiner.de](mailto:repair@reiner.de)

### **Sales**

Phone: +49 7723 657-385

E-mail: [customerservice@reiner.de](mailto:customerservice@reiner.de)

© 2026 Ernst Reiner GmbH & Co. KG

All rights reserved. Translation, reprint and other reproduction of these operating instructions, even in parts and no matter the form, shall require our express written consent. We reserve the right to make content changes to these operating instructions without notice.

# Index

## - A -

Accessories 60  
 Activate Bluetooth 32  
 Activate/deactivate Bluetooth 12

## - C -

Calling up the menu navigation on the device 11  
 Cartridge change 11  
 Changing the print cartridge 51  
 Charging rechargeable batteries 24  
 Clean nozzles 54  
 Commissioning of the jetStamp 990 23  
 Configuring the print image 41  
 Contact 61

## - D -

Date/Time  
   Change Date/Time ((date/time change) 12  
   Presettings 44  
   Summertime 12  
 Device info  
   Counter lifetime 17  
   ESP32 version 17  
   Model 17  
   Software version 17  
 Device lock  
   Activate/deactivate device lock 11  
 Device settings date/time/numbering machine 37  
 Display and button functions 8

## - E -

Edit print image with hotkey function 31  
   Edit numbering machine 31  
   Edit text 31  
 Establishing Bluetooth connection 40  
 Example workflow: Generating the print image  
   Configuring the print image 40, 41  
   Print image transfer 41  
   Printing the print image 40  
   Transferring the print image to jetStamp 990 40

## - F -

File 37  
 Find REINER Bluetooth devices 37  
 Firmware update 33

## - H -

Help 38  
 Hotkey 17

## - I -

Info 38  
 Inserting rechargeable batteries 24  
 Inserting the print cartridge 25  
 Installing the software 33

## - M -

Main menu:  
   Bluetooth Activate (activate Bluetooth) 11  
   Cartridge change 11  
   Date/time 11  
   Device lock 11  
   Hotkey (shortcut key) 11  
   Maintenance 11  
   Model version 11  
   Numbering machine 11  
   Settings 11  
 Maintenance 51  
   Clean head START 15  
   Clean housing 55  
   Clean print carriage 54  
   Cleaning the contacts of the print cartridge 53  
 Manual nozzle cleaning 54  
 Menu bar  
   Edit 36  
   File 36  
   Help 36  
   Presettings 36  
   View 36

## - N -

Numbering machine  
   Context menu text object 50  
   Presettings 48  
 Numbering machine (numbering machine 1 - 4)

Numbering machine (numbering machine 1 - 4)  
 Maximum 12  
 Minimum 12  
 Repetition 12  
 Reset 12  
 Step width 12  
 Value 12

**- O -**

Objects 39  
 Objects settings  
 Context menu date/time object 44  
 Context menu text object 42  
 Date/Time 42, 44  
 Numbering machine 42, 47  
 Presettings 42, 44  
 Text 42  
 Operating elements 6  
 Operating interface 36  
 Menu bar 36  
 Objects 39  
 Toolbar 38  
 Overview of stored print images 29

**- P -**

Preparing jetStamp 990 for REINER PCset 35  
 Print image transfer 41  
 Printing the print image 28

**- R -**

Rechargeable batteries  
 Reaching full capacity 19  
 Recharging 19  
 Recognising and removing interferences 56  
 REINER PCset 32  
 Repetition 14  
 Reset (zero) 13

**- S -**

Safe handling of print cartridges 22  
 Safety notes 22  
 Safety notes on rechargeable batteries 21  
 Safety, description 20  
 Saved print images 29  
 Selecting print image on device 31  
 Setting hotkeys on the device 31

Setting summertime 27  
 Settings  
 Cartridge type 15  
 Double print 15  
 Ext. trigg. delay 15  
 Factory settings 15  
 Operating mode 15  
 Password change 15  
 Password menu 15  
 Print alignment 0 / 180 deg 15  
 Step width 14  
 Switching the device on and off 25  
 System requirements 33

**- T -**

Tab File - Settings Date / Clock time 45  
 Tab File - Settings Date/time/numbering machine 49  
 Technical data 59  
 Technical data and accessories 58  
 Text  
 Context menu text object 43  
 Presettings 42  
 Toolbar 38  
 Transferring the print images 37  
 Transport and disposal 60  
 Type plate 58

**- U -**

Upload print images 37

**- V -**

Value (value of the selected numbering machine 13

**- W -**

Warning messages 56

**- Y -**

Your safety  
 Safe handling of print cartridges 20  
 Safety notes 20  
 Safety notes on rechargeable batteries 20  
 Safety, description 20



**REINER**

[www.reiner.de](http://www.reiner.de)

 **Centre of  
Excellence  
for TPM**  
at Ansbach University  
of Applied Sciences  
[www.cetpm.de](http://www.cetpm.de)

